



**AYRLITE®**

PROFILES & ASSEMBLY ACCESSORIES BOOKLET

## PROFILES & ASSEMBLY ACCESSORIES

Smart & Simple

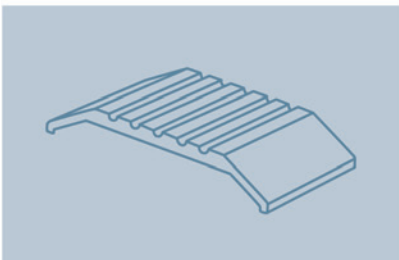
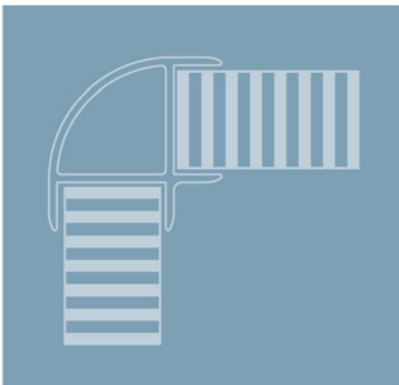
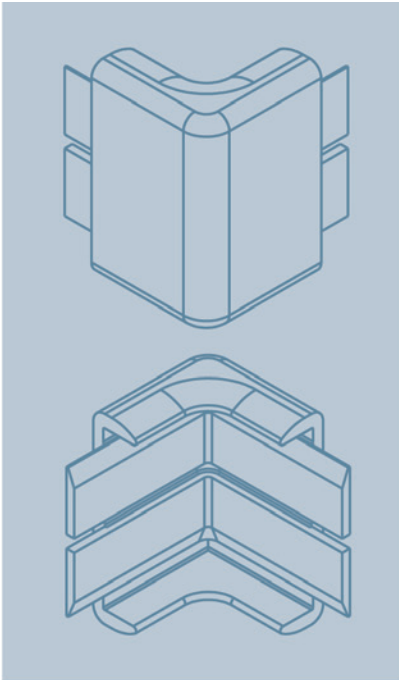



# AYRLITE®

PROFILES & ASSEMBLY ACCESSORIES

The AYRLITE® Profiles & Assembly Accessories are an integral component of the AYRES Lightweight Panel Systems for MARINE applications. It provides a labour efficient and aesthetically enhancing assembly method and completes the AYRES Lightweight Panel Systems approach. It consists of several profiles and assembly accessories to suit 6, 10, 20 and 30mm panels.

## FEATURES

- Aluminium alloy 6063 T5
- Suits 6mm, 10mm, 20mm and 30mm
- Standard profile length is 4,900mm. Half length of 2,440mm are also available
- Clear anodized finish, 10µm thickness

## FABRICATION

- AYRLITE® honeycomb panels are assembled with profiles using polyurethane adhesive e.g. Sikaflex 291. For ACP81247 and ACP80356 the AYRLITE aluminium honeycomb panel edges are slotted to accept the profile tongue
- An AYRLITE® Assembly & Fabrication Techniques DVD is available on request

## SAFETY

As with cutting operations on most materials, avoid inhalation and eye contact with machining dust. Wear protective equipment such as hearing protection and safety glasses during any cutting operations. Use machine guards. Wear gloves to avoid cuts. Wash hands before eating, drinking or smoking and after finishing work.

## Profiles & Assembly Accessories Applications



Door System

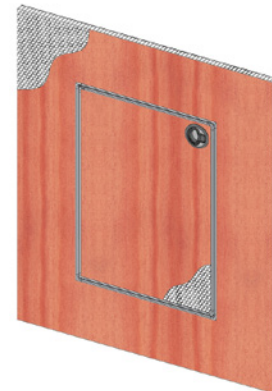

Access Panel



Furniture



6mm Profiles

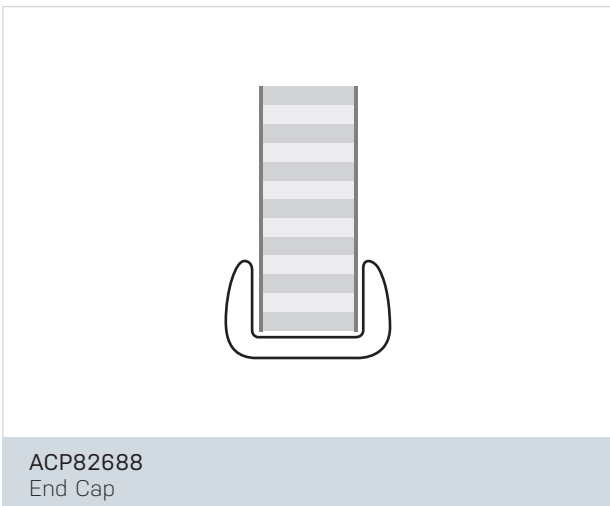
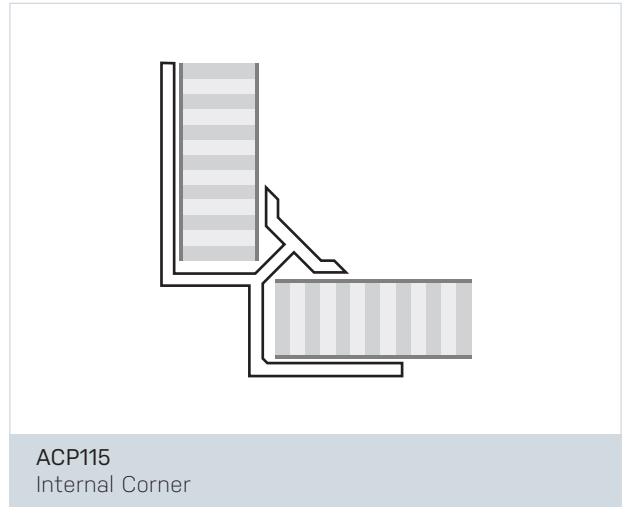
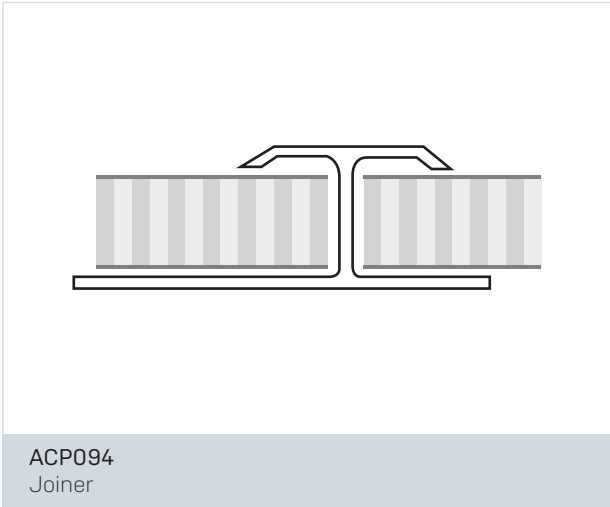



10mm Profiles

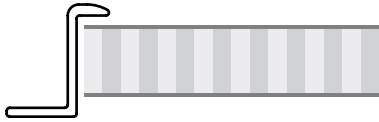

ACP8587  
Cabinet Door Jamb

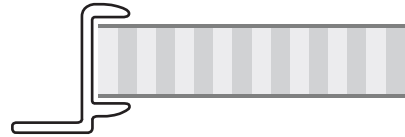

ACP81567  
Cabinet Door Jamb with Retainer

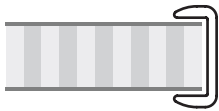

ACP131  
End Cap

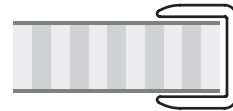

ACP83110  
Channel

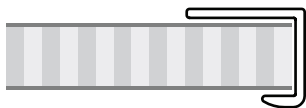

ACP80991  
End Stop





10mm Profiles

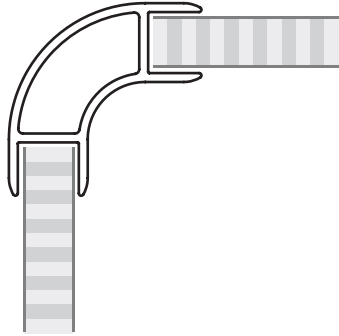

ACP83217  
Corner Post

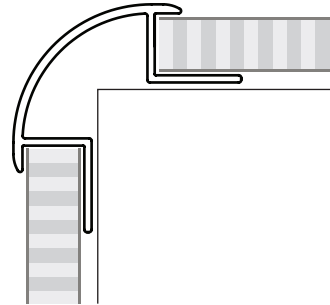

ACP81679  
Corner Post Shallow Fit

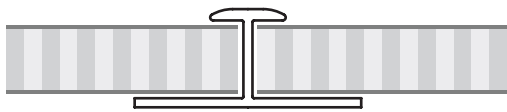

ACP130  
Joiner

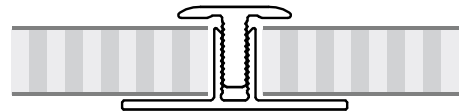

ACP81550 2 Part Joiner Female  
ACP81878 2 Part Joiner Male

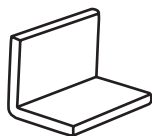

ACP81665  
L Section





20mm Profiles

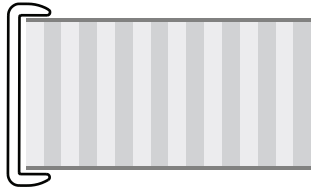

ACP80360  
End Cap

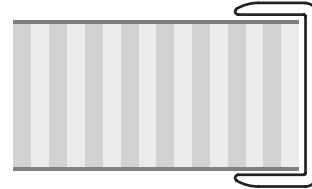

ACP83114  
Channel Shallow

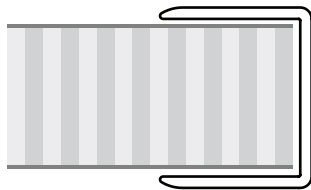

ACP81248  
Channel Deep

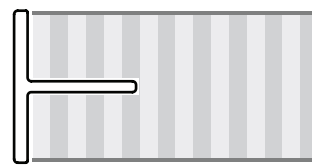

ACP81247  
T Section

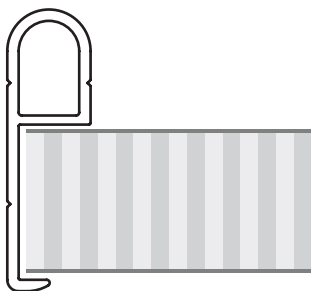

ACP8667  
Shelf Edge





20mm Profiles

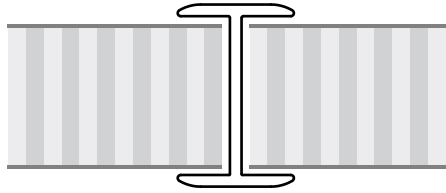

ACP82896  
H Joinder Shallow

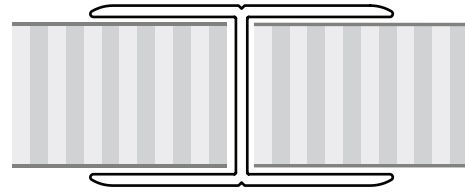

ACP81520  
H Joinder Deep

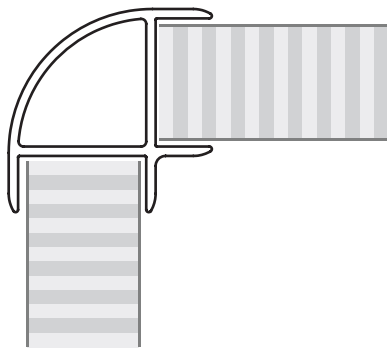

ACP83108  
Corner Post

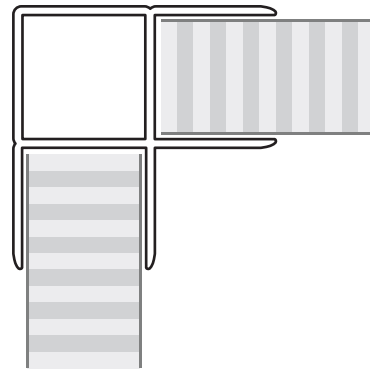

ACP81636  
Corner Joiner

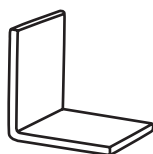

ACP81587  
L Section





20mm Profiles

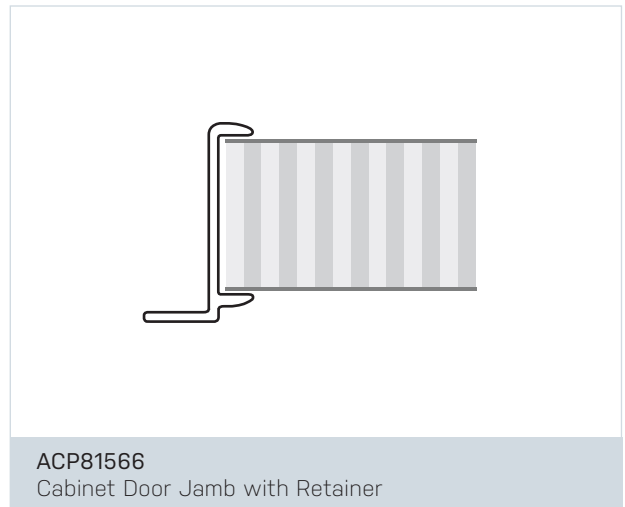
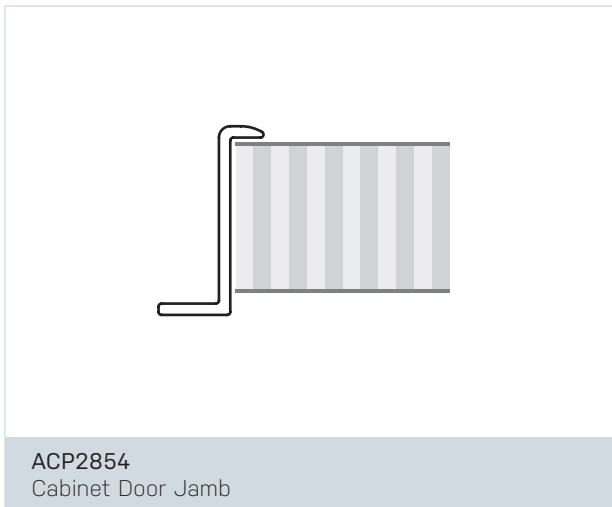





Universal Profiles

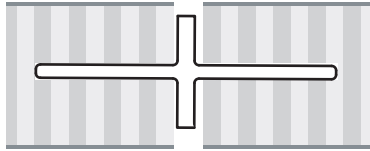

**ACP80356**  
Internal Joiner (Suitable for Panels 10mm and over)

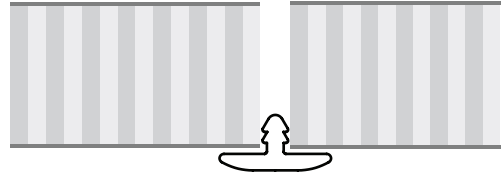

**ACP81631**  
Bead Strip Serrated Tongue

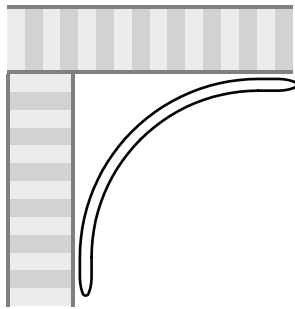

**ACP80361**  
Corner Trim

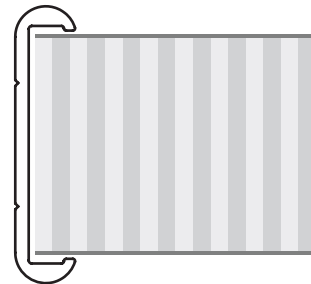

**ACP83107**  
Table Edge 30mm Flush Surface



**ACP81662**  
Sealing Strip Retainer



20mm Door System



ACP80197  
Door Stile

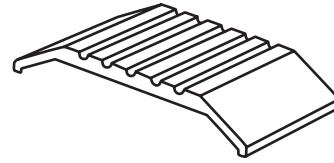

ACP81664  
Threshold

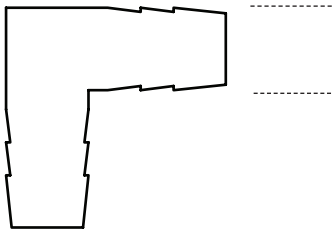

ACP25824  
Door Jamb Joiner

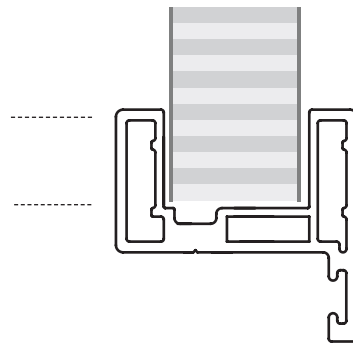

ACP83220  
Door Jamb

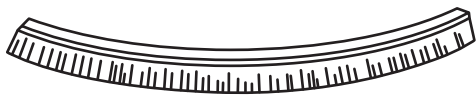

Felt Brush Pile

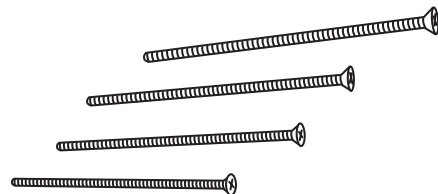

Countersunk Posi Drive S/S Screws





Skirting System

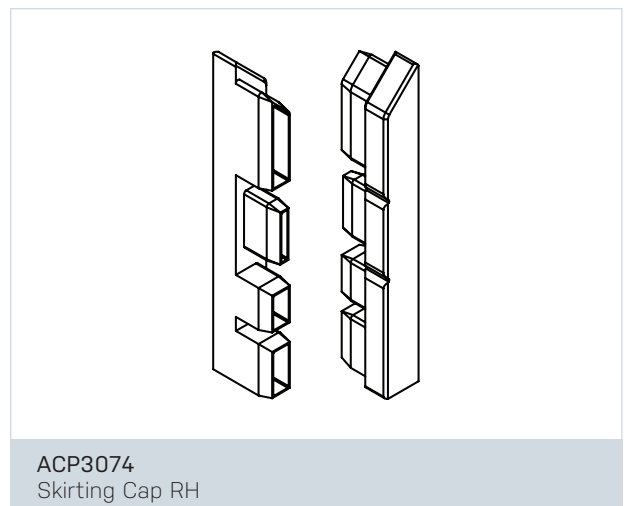
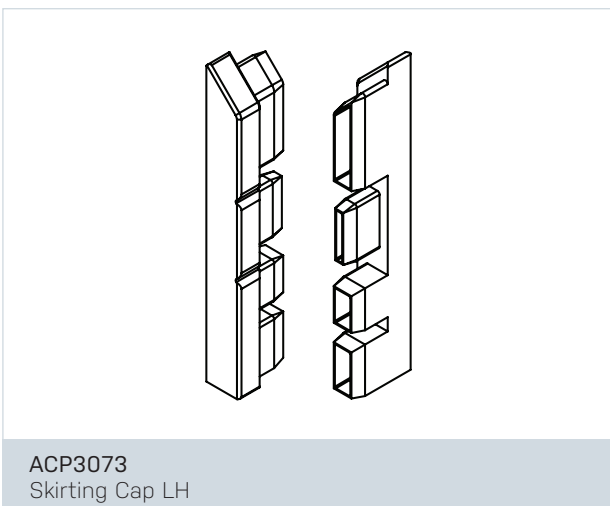
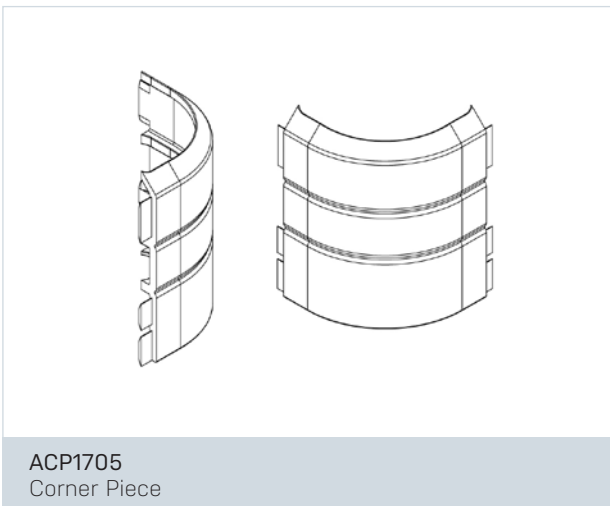
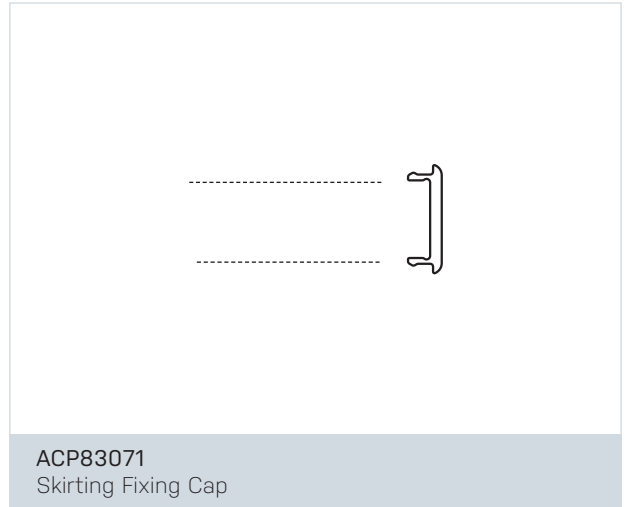
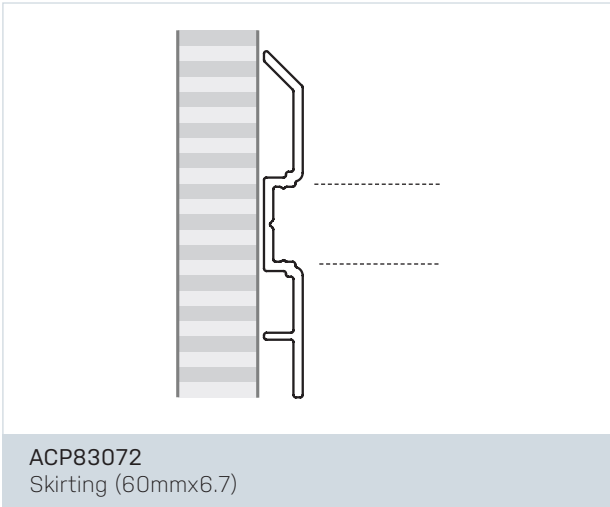



10mm Assembly Accessories

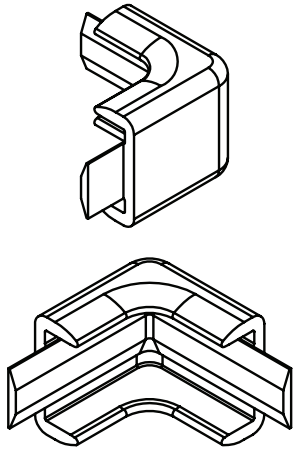

ACP1432  
External Corner

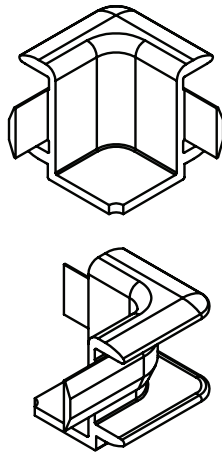

ACP1434  
Internal Corner

20mm Assembly Accessories

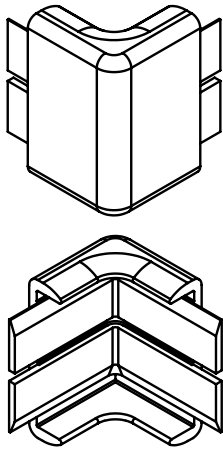

ACP1532A  
External Corner

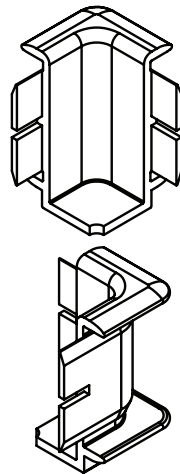

ACP1534  
Internal Corner

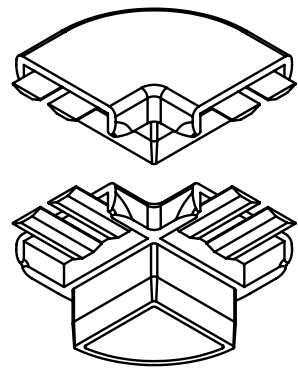

ACP1602  
Corner Cap





20mm Assembly Accessories

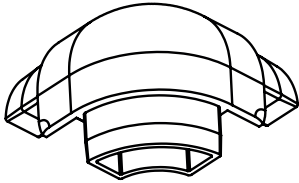

ACP1603  
3 Way Joiner



AYRLITE® 3 Way Joiner

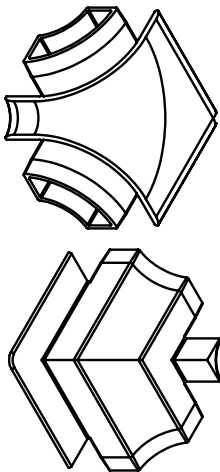

ACP1604  
Internal Joiner



AYRLITE® Internal Joiner





DESCRIPTION	WEIGHT	DESCRIPTION	WEIGHT
<b>6mm Profiles</b>		<b>20mm Door System</b>	
ACP094 Joiner	0.13 kg/m	ACP25824 Door Jamb Joiner	30gm/Set of 4
ACP115 Joiner	0.18 kg/m	ACP80197 Door Stile	1.16 kg/m
ACP82688 End Cap	0.06 kg/m	ACP81664 Threshold	0.76 kg/m
		ACP83220 Door Jamb	0.64 kg/m
		Felt Brush Pile	
		Stainless Steel Screws	
<b>10mm Profiles</b>		<b>Skirting System</b>	
ACP130 Joiner	0.17 kg/m	ACP1705 Corner Piece	11.4 gm
ACP131 End Cap	0.07 kg/m	ACP3073 Skirting Cap LH	3 gm
ACP80991 End Stop	0.10 kg/m	ACP3074 Skirting Cap RH	3 gm
ACP81550 2 Part Joiner Female	0.16 kg/m	ACP83071 Skirting Fixing Cap	0.07 kg/m
ACP81567 Cabinet Door Jamb with Retainer	0.11 kg/m	ACP83072 Skirting (60mm x 6.7mm)	0.33 kg/m
ACP81665 L Section	0.09 kg/m		
ACP81679 Corner Post Shallow Fit	0.35 kg/m		
ACP81878 2 Part Joiner Male	0.14 kg/m		
ACP83110 Channel	0.11 kg/m		
ACP83217 Corner Post	0.44 kg/m		
ACP8587 Cabinet Door Jamb	0.09 kg/m		
		<b>10mm Assembly Accessories</b>	
		ACP1432 External Corner	1.0 gm
		ACP1434 Internal Corner with Jamb	1.0 gm
<b>20mm Profiles</b>		<b>20mm Assembly Accessories</b>	
ACP2854 Cabinet Door Jamb	0.16 kg/m	ACP1532A External Corner	2.0 gm
ACP80360 End Cap	0.12 kg/m	ACP1534 Internal Corner with Jamb	2.0 gm
ACP81247 T Section	0.12 kg/m	ACP1602 Corner Cap	4.8 gm
ACP81248 Channel Deep	0.24 kg/m	ACP1603 3 Way Joiner	16.3 gm
ACP81520 H Joiner Deep	0.40 kg/m	ACP1604 Internal Joiner	10.6 gm
ACP81566 Cabinet Door Jamb with Retainer	0.17 kg/m		
ACP81587 L Section	0.17 kg/m		
ACP81636 Corner Joiner	0.67 kg/m		
ACP82896 H Joiner Shallow	0.20 kg/m		
ACP83108 Corner Post	0.46 kg/m		
ACP83114 Channel Shallow	0.16 kg/m		
ACP8667 Shelf Edge	0.27 kg/m		
<b>30mm Profiles</b>			
ACP83107 Table Edge Flush Surface	0.24 kg/m		
<b>Universal Profiles</b>			
ACP80356 Internal Joiner	0.12 kg/m		
ACP80361 Corner Trim	0.18 kg/m		
ACP81631 Bead Strip Serrated Tongue	0.05 kg/m		
ACP81662 Sealing Strip Retainer	0.06 kg/m		





# AYRLITE®

PROFILES & ASSEMBLY ACCESSORIES



**AYRES**  
Lightweight Panel Systems

**Ayres Composite Panels Pty Ltd**

25-27 Clune Street Bayswater

WA 6053, Australia

T: +61 (0) 8 9279 3426

[enquiries@ayrescom.com](mailto:enquiries@ayrescom.com)

**Ayres Composite Panels USA LLC**

5460 Business Parkway Theodore

Alabama 36582, USA

T: +1 251.653.0700

[usa@ayrescom.com](mailto:usa@ayrescom.com)

[www.ayrescom.com](http://www.ayrescom.com)

**AYRES | *Lighten Up!***

Issue 1

\* Registered Trade Mark of Ayres Composite Panels

**IMPORTANT** All information is given in good faith but without acceptance of liability. Ayres Composite Panels reserves the right to alter specification without prior notice. It remains the responsibility of the customer to ensure the suitability of any product for the purposes intended. All sales are made subject to Ayres Composite Panels [standard terms and conditions of sale](#). Please direct all [enquiries here](#).